



Kitchen Appliances Collection
2015 Vol.2

HOB 3

- Gas Hob
- Induction Hob
- Electric Hob

OVEN 9

- Electric Oven
- Microwave Oven
- Steam Oven

COOKER HOOD 16

- Chimney Type Hood
- Standard Type Hood
- Island Type Hood
- Telescopic Type Hood

WINE COOLER 23

REFRIGERATOR 27

LAUNDRY 30

TELEVISION 32

- Kitchen TV
- Bathroom TV

BUILT-IN STERILIZER 35

PROJECT REFERENCE 36



GAS HOB 氣體爐

Enjoy the built-in aesthetics and easy to clean convenience

G7206ABT-1

\$3,280



Power:
(Left) 5600W/ (Right) 5600W(TG)
(Left) 4300W/ (Right) 4300W(LPG)

火力:
(左)5600瓦 / (右)5600瓦(煤氣)
(左)4300瓦 / (右)4300瓦(石油氣)

Function:
Gas safety device / Electronic
ignition / D size (1.5V) battery cell /
Tempered Glass

功能:
防漏熄火安全裝 / 乾電池點火 / D型
(1.5伏特) 乾電池 / 強化玻璃

Gas type: TG / LPG

氣體種類: 煤氣 / 石油氣

Dimension:
Unit - 760W x 450D x 65H (mm)
Cut out - 705W x 395D (mm)

尺寸:
機身- 760闊 x 450深 x 65高 (毫米)
開孔- 705闊 x 395深 (毫米)

G7301DWT-1

\$3,680



Power:
(Left) 5000W/ (Centre) 1100W/
(Right) 5000W(TG)
(Left) 4500W/ (Centre) 1000W/
(Right) 4500W(LPG)

火力:
(左)5000瓦 / (中)1100瓦 /
(右)5000瓦 (煤氣)
(左)4500瓦 / (中)1000瓦 /
(右)4500瓦 (石油氣)

Function:
Gas safety device / Electronic
ignition / D size (1.5V) battery cell /
Tempered Glass

功能:
防漏熄火安全裝 / 乾電池點火
D型(1.5伏特) 乾電池 /
強化玻璃

Gas type: TG / LPG

氣體種類: 煤氣 / 石油氣

Dimension:
Unit - 860 x 450D x 55H (mm)
Cut out - 710W x 400D (mm)

尺寸:
機身- 860闊 x 450深 x 55高(毫米)
開孔- 710闊 x 400深(毫米)

Gas Hob 氣體爐

V291VNRC-1

\$3,200



Power: 5000W (TG)
4500W (LPG)

火力：5000 瓦 (煤氣)
4500 瓦 (石油氣)

Function:
Flame failure device/ Electronic ignition/
D size (1.5V) battery cell /Euro Kera®
Ceramic glass top (Made in France)

功能：
安全熄火裝置 / 乾電池點火 /
D 型 (1.5 伏特) 乾電池 /
Euro Kera® / 強化玻璃
(法國製造)

Gas type :TG/ LPG

氣體種類：煤氣 / 石油氣

Dimension:
Unit -290 (W) x 510 (D) x 65 (H)mm
Cut out - 255 (W) x 475 (D) (mm)

尺寸：
機身 - 290 闊 x 510 深 x 65 高 (毫米)
開孔 - 255 闊 x 475 深 (毫米)

C291VNRC-1

\$2,680



Power: 5000W (TG)
4500W (LPG)

火力：5000 瓦 (煤氣)
4500 瓦 (石油氣)

Function:
Flame failure device/ Electronic ignition/
D size (1.5V) battery cell /Tempered
glass

功能：
安全熄火裝置 / 乾電池點火 /
D 型 (1.5 伏特) 乾電池 /
強化玻璃

Gas type :TG/ LPG

氣體種類：煤氣 / 石油氣

Dimension:
Unit -290 (W) x 510 (D) x 65 (H)mm
Cut out - 255 (W) x 475 (D) (mm)

尺寸：
機身 - 290 闊 x 510 深 x 65 高 (毫米)
開孔 - 255 闊 x 475 深 (毫米)

C292VNRC-1

\$2,780



Power: 2500W + 1100W

火力：2500 瓦 + 1100 瓦

Function:
Gas safety device / Electronic ignition /
D size (1.5V) battery cell
Flame failure device / Tempered glass

功能：
安全閥 / 乾電池點火 /
D 型 (1.5 伏特) 乾電池 /
安全熄火裝置 / 強化玻璃

Gas type :TG

氣體種類：煤氣

Dimension:
Unit - 290 (W) x 510 (D) x 65 (H)mm
Cut out -255 (W) x 475 (D)(mm)

尺寸：
機身 - 290 闊 x 510 深 x 65 高 (毫米)
開孔 - 255 闊 x 475 深 (毫米)

CRISTAL

INDUCTION HOB 電磁爐

New experience by flameless cooking

Built-in installation, please refer to p.8 fig.1 before installation of induction cooker
嵌入式安裝，請參閱第 8 頁圖 1 指示，然後安裝電磁爐

CI-77S4

Italy Made in Italy

\$8,800



Power:

(Front left) 2300W / (Rear left) 1400W
(Front right) 1400W / (Rear right) 2300W

Function:

9 Heating Power levels / Touch control/
Child lock safety / Timer / Overflow safety
device / Pot diameter detector /
Euro Kera® / Ceramic glass top
(Made in France)

Current: 40 Amp

Dimension:

Unit - 770W x 510D x 50H (mm)
Cut out - 760W x 500D (mm)

火力:

(前左) 2300 瓦 / (後左) 1400 瓦
(前右) 1400 瓦 / (後右) 2300 瓦

功能:

9 段火力控制 / 輕觸式控制 / 兒童安
全鎖 / 時間掣 / 滾瀉自動關機功能 /
鍋具檢測功能 / Euro Kera® 瓷化玻
璃 (法國製造)

電流: 40 安培

尺寸:

機身 - 770 闊 x 510 深 x 50 高 (毫米)
開孔 - 760 闊 x 500 深 (毫米)

CI-58S3

Italy Made in Italy

\$7,800

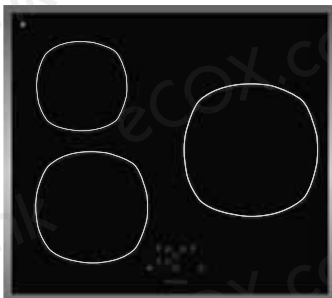

Power:

(Front left) 2300W / (Rear left) 1400W /
(Right) 2300W

Function:

9 Heating Power levels / Touch control
/ Timer / Child safety lock / Overflow
safety device / Pot diameter detector /
Euro Kera® Ceramic glass top
(Made in France)

Current: 30Amp

Dimension:

Unit - 580W x 510D x 50H (mm)
Cut out - 570W x 500D (mm)

火力:

(前左) 2300W / (後左) 1400W /
(右) 2300W

功能:

9 段火力控制 / 輕觸式控制 /
時間掣 / 兒童安全鎖 / 滾瀉自動
關機功能 / 鍋具檢測功能 / Euro
Kera® 瓷化玻璃
(法國製造)

電流: 30 安培

尺寸:

機身 - 580 闊 x 510 深 x 50 高 (毫米)
開孔 - 570 闊 x 500 深 (毫米)

Induction Hob 電磁爐

Built-in installation, please refer to p.8 fig.1 before installation of induction cooker
嵌入式安裝，請參閱第 8 頁圖 1 指示，然後安裝電磁爐

CI-238PS

\$3,980



Power:
(Left) 2800W / (Right) 2800W
Dual Burner-Power: sharing up to 2950W

Function:
9 Heating Power levels / 9 Temperature settings / Touch control / Child lock / Timer / Euro Kera® ceramic glass top (Made in France) / Suitable for built-in or free stand installation

Current: 13 Amp

Dimension:
Unit - 700W x 410D x 75H (mm)
Cut out - 655W x 385D (mm)

火力:
(左)2800 瓦 / (右)2800 瓦
雙爐頭共享火力：最高可達 2950 瓦

功能:
9 種火力控制 / 9 種溫度控制 / 輕觸式控制 / 兒童安全鎖 / 時間掣 / Euro Kera® 瓷化玻璃 (法國製造) / 適合嵌入式或座枱式安裝

電流: 13 安培

尺寸:
機身 - 700 闊 x 410 深 x 75 高 (毫米)
開孔 - 655 闊 x 385 深 (毫米)

CI-298PS1

\$2,980



Power:
(Left) 2000W / (Right) 2600W
Dual burner -Power: sharing up to 2950W

Function:
Slide touch Control / Timer / Touch control / Child lock / Ceramic glass top / Suitable for built-in or free stand installation / 9 Heating Power levels / Chinese soup programming

Current: 13 Amp

Dimension:
Unit - 700W x 400D x 60H (mm)
Cut out - 660W x 370D(mm)

火力:
(左)2000 瓦 / (右)2600 瓦
雙爐頭共享火力：最高可達 2950 瓦

功能:
滑指觸控 / 時間掣 / 輕觸式控制 / 兒童安全鎖 / 瓷化玻璃 / 適合嵌入式或座枱式安裝 / 9 段火力控制 / 中式煲湯程式

電流: 13 安培

尺寸:
機身 - 700 闊 x 400 深 x 60 高 (毫米)
開孔 - 660 闊 x 370 深 (毫米)

PE2926ID

\$4,380



Power:
(Front) 2600W / (Rear) 1600W
Dual burner-Power: sharing up to 2600W

Function:
Timer / 8 Heating Power levels / Touch control / Residual heat caution indicator / Child lock / Euro Kera® ceramic glass top (Made in France) / Suitable for built-in or free stand installation

Current: 13 Amp

Dimension:
Unit - 290W x 510D x 60H (mm)
Cut out - 278W x 498D (mm)

火力:
(前)2600 瓦 / (後)1600 瓦
雙爐頭共享火力：最高可達 2600 瓦

功能:
時間掣 / 8 段火力控制 / 輕觸式控制 / 餘溫提示燈 / 兒童安全鎖 / Euro Kera® 瓷化玻璃 (法國製造) / 適合嵌入式或座枱式安裝

電流: 13 安培

尺寸:
機身 - 290 闊 x 510 深 x 60 高 (毫米)
開孔 - 278 闊 x 498 深 (毫米)

Induction Hob 電磁爐

PE2918ID

\$3,380



Power:2800W

火力 :2800 瓦

Function:

功能 :

Timer / 10 Heating Power levels /

時間掣 / 10 段火力控制 /

Touch control / Child lock /

輕觸式控制 / 兒童安全鎖 /

Euro Kera® ceramic glass top (Made in France)

Euro Kera® 瓷化玻璃 (法國製造)

Current: 13 Amp

電流 :13 安培

Dimension:

尺寸 :

Unit - 295W x 510D x 65H (mm)

機身 - 295 闊 x 510 深 x 65 高 (毫米)

Cut out - 285W x 480D (mm)

開孔 - 285 闊 x 480 深 (毫米)

C30SEC

\$1,880



Power: 3000W

火力 :3000 瓦

Function:

功能 :

Timer / 10 Heating Power levels /

時間掣 / 10 段火力控制 /

10 Temperature settings / Stainless

10 種溫度控制 / 不銹鋼機身 /

steel body / Professional cooker for

商業專用 /

commercial Usage / Ceramic glass top /

瓷化玻璃 /

Suitable for free stand installation

適合座枱控制

Current: 15Amp

電流 :15 安培

Dimension:

尺寸 :

Unit - 328W x 420D x 100H (mm)

機身 - 328 闊 x 420 深 x 100 高 (毫米)

Electric Hob 電熱爐

PR58BX

Italy Made in Italy

\$4,880



Power:
2100W + 1800W + 2 x 1200W

Function:
Highlight heating / Knob control /
Residual heat caution / indicator /
Euro Kera® ceramic glass top (Made
in France)

Current: 30Amp

Dimension:
Unit - 580W x 510D x 50H(mm)
Cut out - 565W x 495D (mm)

火力:
2100 瓦 + 1800 瓦 + 2 x 1200 瓦

功能:
紅外線光速熱 / 扭掣式設計 /
餘溫提示燈 /
Euro Kera® 瓷化玻璃 (法國製造)

電流: 30 安培

尺寸:
機身 - 580 闊 x 510 深 x 50 高 (毫米)
開孔 - 565 闊 x 495 深 (毫米)

PR29FX

Italy Made in Italy

\$2,880



Power:
(Front) 1200W / (Rear) 1800W

Function:
Highlight heating / Knob control /
Residual heat caution indicator
Euro Kera® Ceramic glass top
(Made in France)

Current: 15 Amp

Dimension:
Unit - 290W x 510D x 75H(mm)
Cut out - 280W x 500D (mm)

火力:
(前) 1200 瓦 / (後) 1800 瓦

功能:
紅外線光速熱 / 扭掣式控制 /
餘溫提示燈 / Euro Kera® 瓷化玻璃
(法國製造)

電流: 15 安培

尺寸:
機身 - 290 闊 x 510 深 x 75 高 (毫米)
開孔 - 280 闊 x 500 深 (毫米)

Built-in Installation Guideline 嵌入式安裝指引

Please strictly follow the procedures:

- A minimum of 50mm distance to all sidewalls must be ensured.
- Cooker hood must be built with distance of minimum 60 cm above the induction cooker.
- Fixed onto an Oven

When you are going to fix the oven below the induction cooker, you must assure to separate the heat from the oven (at least 15-25mm) and provided good ventilation for induction hob

請嚴格按照程序：

- 安裝嵌入式電磁爐時必須預留四周最少為 50mm 散熱空間。
- 安裝抽油煙機時，電磁爐與焗爐距離必須確保持最少 60 厘米以上。
- 如果安裝在焗爐之上，廚櫃空間須獨立分隔，焗爐之頂部必須裝上隔熱面板，防止熱力影響電磁爐散熱，而電磁爐底部必須最少有 15-25mm 之散熱空間。

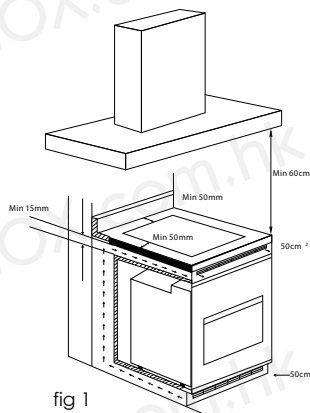

ELECTRIC OVEN 電焗爐

The pleasure to cook everyday for your beloved



MOVIE Made in Italy

\$8,950



Oven pan rails and self-cleaning panels
層架易潔板



Rotisserie
燒烤叉



Shelf
層架



Grill pan and handle
燒烤盤和手柄

Power: 3500W

Function:

8 kinds of function / Electronic timer control / Fan circulation hot air system / Automatic self-cleaning panels / Cool front glass / Enamel oven interior

Maximum temperature: 250°C

5 shelf levels / Alarm Function / Rotisserie

Current: 15 Amp

Capacity: 75L

Dimension: 893W x 538D x 477H (mm)

火力 :3500 瓦

功能 :

8 種烤焗模式 / 電子時間設定及控制 / 熱風循環系統 / 高溫自動清潔板 / 玻璃門冷風系統 / 耐腐蝕、耐磨、耐熱搪瓷內壁 /

最高溫度 :250°C

5 種層架高度 / 響鬧功能 / 旋轉燒烤

電流 :15 安培

內部容量 :75 公升

機身尺寸 : 893 闊 X 538 深 X 477 高 (毫米)



Space for ventilation

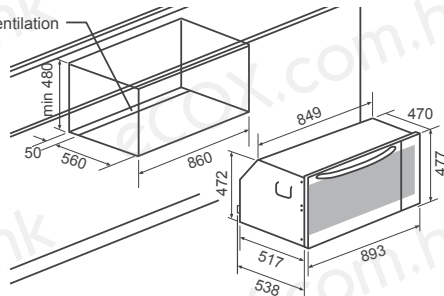

Electric Oven 電焗爐

LIGHT

Italy *Made in Italy*

\$6,380



Power: 2400W

Function:

6 kinds of function / Touch control timer / Fan circulation hot air system / Automatic self-cleaning panels / Cool front glass / Enamel oven interior / Maximum temperature: 250°C / 5 shelf levels / Alarm Function / Rotisserie

Current: 13Amp

Capacity: 58L

Dimension: 594W x 535D x 594H (mm)



Oven pan rails and self-cleaning panels
層架易潔板



Shelf
層架



Grill pan
燒烤盤



Rotisserie
燒烤叉

火力: 2400 瓦

功能:

6 種烤焗模式 / 輕觸式時間設定及控制 / 熱風循環系統 / 高溫自動清潔板 / 玻璃門冷風系統 / 耐腐蝕、耐磨、耐熱搪瓷內壁 / 最高溫度: 250°C / 5 種層架高度 / 響鬧功能 / 旋轉燒烤

電流: 13 安培

內部容量: 58 公升

機身尺寸: 594 闊 X 535 深 X 594 高 (毫米)



WAVE

Italy *Made in Italy*

\$5,880



Power: 2400W

Function:

6 kinds of function / Electronic timer control / Fan circulation hot air system / Automatic self-cleaning panels / Cool front glass / Enamel oven interior / Maximum temperature: 250°C / Multiple shelf level / Alarm Function / Rotisserie

Current: 13 Amp

Capacity: 58L

Dimension: 594W x 535D x 594H (mm)



Oven pan rails and self-cleaning panels
層架易潔板



Rotisserie
燒烤叉



Shelf
層架



Grill pan and handle
燒烤盤和手柄

火力: 2400 瓦

功能:

6 種烤焗模式 / 電子時間設定及控制 / 熱風循環系統 / 高溫自動清潔板 / 玻璃門冷風系統 / 耐腐蝕、耐磨、耐熱搪瓷內壁 / 最高溫度: 250°C / 多層架高度 / 響鬧功能 / 旋轉燒烤

電流: 13 安培

內部容量: 58 公升

機身尺寸: 594 闊 X 535 深 X 594 高 (毫米)



CHARME

Italy *Made in Italy*

\$6,980



Power: 3300W

Function:

9 functions for grill / 9 kinds of function / Automatic self-cleaning panels / Electronic timer control / Automatic pre-set program / Fan circular hot air system / Cool front glass / Grill with roast spike / Multiple level grill shelves

Current: 15 Amp

Capacity: 58L

Dimension: 594W x 535D x 594H (mm)



Oven pan rails and self-cleaning panels
層架易潔板



Rotisserie
燒烤叉



Shelf
層架



Grill pan and handle
燒烤盤和手柄

火力: 3300 瓦

功能:

9 種烤焗模式 / 高溫自動清潔板 / 電子時間及操作 / 自動烤焗程式 / 熱風循環系統 / 玻璃門冷風系統 / 旋轉燒烤叉







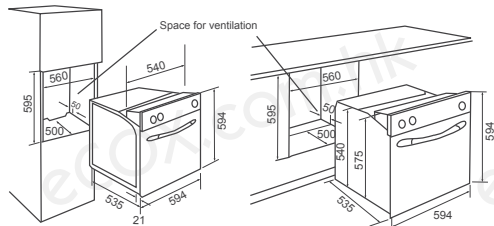





電流: 15 安培

內部容量: 58 公升

機身尺寸: 594 闊 X 535 深 X 594 高 (毫米)



Electric Oven 電焗爐

Function Icons 功能圖標	Function Descriptions 功能說明	Illustration Details 插圖詳細
	Oven Lamp 焗爐照明燈	<ul style="list-style-type: none"> Oven light will stay on 焗爐照明燈開啟
	Top & Bottom Heat Setting 頂部及底部同時發熱系統	<ul style="list-style-type: none"> Conventional cooking mostly used to cook or heat up single dish. Place the food inside the oven. Set desired cooking temperature 多適用於烹調同一盆或同類食物
	Bottom Heat Setting 底部發熱系統	
	Bottom Fan Heat Element 底部發熱加循環風系統	<ul style="list-style-type: none"> The circulation fan installed at back of oven allows even hot air circulation inside the oven This is an ideal method for cooking dishes placed on different shelves. Especially when the foods are of different kinds (fish, meat etc.) 循環熱風系統可令食物平均受熱烤焗，多適用於多盆或不同類食物同時內一同烤焗 (如魚類、肉類等)
	Top & Bottom Fan Heat Element 頂部及底部發熱加循環系統	
	Circular Fan Heating Element 熱風循環系統	
	Bottom Heating Element Circular Fan Heating Element 底部發熱加熱風循環系統	
	Soft Roasting Grill 頂部柔和燒烤	<ul style="list-style-type: none"> Preheat the oven for 5 minutes Place the food on the 1st or 2nd shelves Please use the rotisserie or grill pan to cook the food 先將焗爐預熱 5 分鐘 將食物放置於第一或第二格內 使用烤盆或燒烤叉烤製
	Strong Roasting Grill 頂部重點強力燒烤	
	Soft Roasting Grill with Fan 頂部柔和燒烤及循環風系統	
	Strong Roasting Grill with Fan 頂部重點強力燒烤及循環風系統	
	Fan for Defrost Setting (Thermostat setting is not necessary) 循環風解凍系統	<ul style="list-style-type: none"> Thermostat setting is not necessary. The fan will allow air to circulate inside the oven to defrost the frozen food. 毋須設定溫度，利用循環風快速令食物自然解凍。



Oven 60cm cube
EXTRA LARGE (XL)
特大 (XL) 60 厘米大
方體烤箱



Rotisserie
燒烤叉



Side and rear self-
cleaning
catalytic liners
兩側和後方催化易潔板



Removable side racks
卸除式側架



Side light
Grill pan and handle
邊燈
烤盤和手柄

COMBI MICROWAVE OVEN

微波燒烤焗爐

Functional cooking at ease

 **CRISTAL**
MADE IN ITALY



Combi Microwave Oven 微波燒烤焗爐

G34L-900SCGI

\$6,480



Power: 900W(Microwave), 1200W(Grill)
1950W(Convection)

Function: Dot Matrix LCD display / Deluxe Sensor touch control / Multiple cooking method: M/G/C/ Convection type: Up/Rear / Timing setting: Max 95 mins / 11 Microwave Power Levels / 4 combination cooking temperature settings / 10 convection cooking temperature settings / Speedy And Weight Defrost (meat, poultry, seafood) / Preset Function: Digital Clock(12/24 hours system) / Child Lock Safety / 7 automatic cooking menus

Capacity: 34L

Dimension: Unit- 595W x 555D x 460H (mm)
Cut out- 560W x 550D x 455H(mm)

火力: (微波) 900 瓦, (燒烤) 1200 瓦,
(對流) 1950 瓦

功能: 點陣式液晶顯示器 / 豪華感應觸摸控制 / 多種烹飪方式: M/G/C/ 對流式: 上/後 / 定時設置: 最多 95:00 分鐘 / 11 段微波控制 / 4 段烹調溫度組合設置 / 10 段對流烹調溫度設置 / 快速解凍 (肉、家禽、海鮮 / 烹調結束信號 / 預設功能的數字時鐘 (12/24 小時制 / 兒童安全鎖 / 7 種自動烹飪菜單

內部容量: 34 公升

機身尺寸: 機身 595 闊 X 555 深 X 460 高 (毫米)
開孔 560 闊 X 550 深 X 455 高 (毫米)

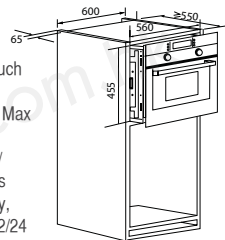

MICROWAVE OVEN

微波爐

Home cooking made easy

C20L-800BVV

\$2,880



Power: 800W(Microwave), 1000W(Grill)
Function: Grill function / 5 Microwave power levels /
Electronic timer / Defrost function /
8 automatic cooking menus / Safety lock /
Stainless steel interior

Capacity: 20L

Dimension: Unit - 460W x 320D x 345H (mm)
Cut-out - 560W x 330D x 380H (mm)

火力: (微波) 800 瓦, (燒烤) 1000 瓦
功能: 燒烤功能 / 5 段微波火力控制
電子計時 / 解凍設定 / 8 種預設菜單 /
安全鎖 / 不銹鋼內壁

內部容量: 20 公升

機身尺寸: 機身 460 闊 X 320 深 X 345 高 (毫米)
開孔 560 闊 X 330 深 X 380 高 (毫米)

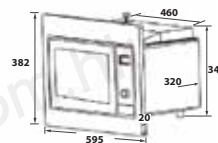
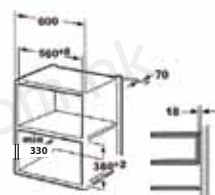

Combi Steam Oven 蒸焗爐

C-30GXP Free Standing Model 座枱式型號

\$4,980



Power: High temperature steam (2100W) / Convection and Grill (1650W) / Steam (1650W)
Function: Steam (50°C - 110°C) / Convection (120°C - 200°C) / Grill (120°C - 200°C) / Pyro Steam (120°C - 200°C) / Disinfection (110°C) / Keep Warm (40°C) / Defrost (60°C) / 15 automatic menu / multi-storage cooking / Knob light-emitting ring design / Children lock safety

Water Tank: 1.3L
Capacity: 28L
Dimension: 525W x 450D x 380H (mm)

火力: 高溫蒸煮 (2100瓦) / 燒烤 (1650瓦) / 蒸煮 (1650瓦)
功能: 蒸煮 (50°C - 110°C) / 燒烤 (120°C - 200°C) / 蒸焗 (120°C - 200°C) / 熱風對流 (120°C - 200°C) / 消毒 (110°C) / 保溫 (40°C) / 解凍功能 (60°C) / 15 預設烹調模式 / 多架烹飪
 旋鈕光環設計 / 兒童安全鎖

水箱容量: 1.3公升
內部容量: 28 公升
 525 闊 X 450 深 X 380 高 (毫米)

C-S28GXH Built-in Model 嵌入式型號

\$5,980



Power: Steam (1650W) / Grill (1650W) / High temperature steam (2100W)
Function: Ordinary Steam / Grill function / Convection / High temperature Steam / Defrost / Keep warm / Sterilization / Child Safety lock / Clock / LCD display

Water Tank: 1.3L
Capacity: 28L
Dimension: Unit - 595W x 450D x 460H (mm)
 Cut out - 560W x 550D x 455H (mm)

火力: 蒸 (1650 瓦) / 燒烤 (1650 瓦) / 高溫蒸煮 (2100 瓦)
功能: 蒸煮 / 燒烤 / 烤焗 / 翻熱 / 高溫蒸煮 / 解凍烹調 / 保溫 / 消毒 / 兒童安全鎖 / 液晶顯示屏 / 烹調完成響鬧提示 / 預設烹調模式

水箱容量: 1.3公升
內部容量: 28 公升
尺寸: 機身 - 595 闊 X 450 深 X 460 高 (毫米)
 開孔 - 560 闊 X 550 深 X 455 高 (毫米)

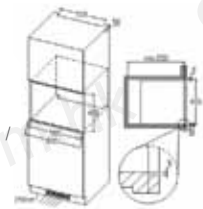
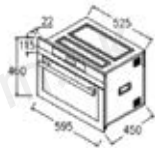

HOODS 抽油煙機

Enjoy the aesthetic interpretation of cutting-edge technology



Island Type Hood 島式抽油煙機

CL9013AMS

\$6,380



Specifications: 3 Speed levels / Push button control /
150mm diameter outlet /
Airflow - 1000m³/hr /
High speed turbo motor

Material: Anti-fingerprint stainless steel

Dimension: 900W x 600D x 600-1100H (mm)

Options: Activated Charcoal carbon filter
規格: 三段風速選擇 / 按掣式控制 /
150 毫米直徑出風位 /
抽風量 - 每小時 1000 立方米 /
高速渦輪式摩打

質料: 防指紋不銹鋼

機身尺寸: 900 闊 x 600 深 x 600-1100 高 (毫米)

***附加:** 可配置活性炭過濾器

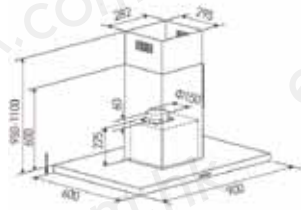

Chimney Type Hood 煙導式抽油煙機

C-H6018

\$2,980



Specifications: 3 Speed levels / Push button control /
150mm diameter outlet /
Airflow - 850m³/hr /
High speed turbo motor

Material: Anti-fingerprint stainless steel
Dimension: 600W x 500D x 400-780H (mm)
***Options:** Activated Charcoal carbon filter
規格: 三段風速選擇 / 按掣式控制 /
150 毫米直徑出風位 /
抽風量 - 每小時 850 立方米 /
高速渦輪式摩打

質料: 防指紋不銹鋼
機身尺寸: 600 闊 x 500 深 x 400-780 高 (毫米)
*** 附加:** 可配置活性炭過濾器

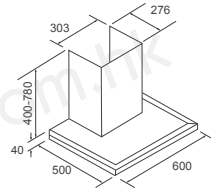

C7005MS

\$3,580



Specifications: 3 Speed levels/ Push button control /
150mm diameter outlet /
Airflow - 1000m³/hr /
High speed turbo motor

Material: Anti-fingerprint stainless steel
Dimension : 700W x 500D x 540 -1030H (mm)
***Options:** Activated Charcoal carbon filter
規格 : 三段風速選擇 / 按掣式控制 /
150 毫米直徑出風位 /
抽風量 - 每小時 1000 立方米 /
高速渦輪式摩打

質料 : 防指紋不銹鋼
機身尺寸 : 700 闊 x 500 深 x 540-1030 高 (毫米)
*** 附加 :** 可配置活性炭過濾器

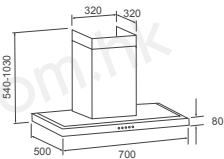

C9002MS

\$3,680



Specifications: 3 Speed levels / Push button control /
150mm diameter outlet /
Airflow - 1000m³/hr /
High speed turbo motor

Material: Anti-fingerprint stainless steel
Dimension: 900W x 500D x 590 - 1080H (mm)
***Options:** Activated Charcoal carbon filter
規格: 三段風速選擇 / 按掣式控制 /
150 毫米直徑出風位 /
抽風量 - 每小時 1000 立方米 /
高速渦輪式摩打

質料: 防指紋不銹鋼
機身尺寸: 900 闊 x 500 深 x 590-1080 高 (毫米)
*** 附加:** 可配置活性炭過濾器

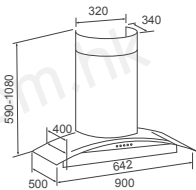

Chimney Type Hood 煙導式抽油煙機

C903ASS

\$3,980



Specifications: 3 Speed levels / Push button control / 150mm diameter outlet /

Airflow - 900m³/hr / High speed turbo motor / Micro computer LED display

Material: Anti-fingerprint stainless steel

Dimension: 900W x 500D x 400-780H (mm)

***Options:** Activated Charcoal carbon filter

規格: 三段風速選擇 / 按掣式控制 / 150 毫米直徑出風位 / 風量 - 每小時 900 立方米 / 高速渦輪式摩打 / 微電腦 LED 顯示

質料: 防指紋不銹鋼

機身尺寸: 900 闊 x 500 深 x 400-780 高 (毫米)

*** 附加:** 可配置活性炭過濾器

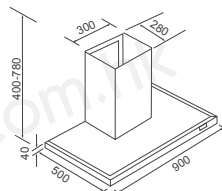

C9005MS

\$3,980



Specifications: 3 Speed levels / Push button control / 150mm diameter outlet /

Airflow - 1000m³/hr / High speed turbo motor

Material: Anti-fingerprint stainless steel

Dimension: 900W x 500D x 540 -1030H (mm)

***Options:** Activated Charcoal carbon filter

規格: 三段風速選擇 / 按掣式控制 / 150 毫米直徑出風位 / 抽風量 - 每小時 1000 立方米 / 高速渦輪式摩打

質料: 防指紋不銹鋼

機身尺寸: 900 闊 x 500 深 x 540-1030 高 (毫米)

*** 附加:** 可配置活性炭過濾器

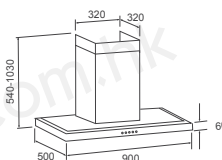

C9006ES

\$4,380



Specifications: 3 Speed levels + turbo mode / Touch control / 150mm diameter outlet /

Airflow - 1000m³/hr / High speed turbo motor

Material: Anti-fingerprint stainless steel

Dimension: 900W x 500D x 540-1030H (mm)

***Options:** Activated Charcoal carbon filter

規格: 三段風速選擇 + 高速模式 / 輕觸式控制 / 150 毫米直徑出風位 / 抽風量 - 每小時 1000 立方米 / 高速渦輪式摩打

質料: 防指紋不銹鋼

機身尺寸: 900 闊 x 500 深 x 540-1030 高 (毫米)

*** 附加:** 可配置活性炭過濾器

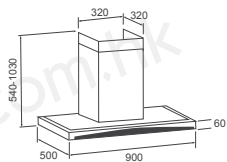

Chimney Type Hood 煙導式抽油煙機

C9008A Automatic slide-out operation 自動伸縮開關

\$4,980



Specifications: 3 Speed levels / Push button control /
150mm diameter outlet /
Airflow - 1000m³/hr / High speed turbo motor /
Automatic telescopic system /
Micro computer LED display

Material: Anti-fingerprint stainless steel
Dimension: 900W x 308-485D x 500-980H (mm)

Options: Activated Charcoal carbon filter
規格: 三段風速選擇 / 按掣式控制 /
150 毫米直徑出風位 / 抽風量 - 每小時 1000 立方米 /
高速渦輪式摩打 / 自動油壓式伸縮開關 /
微電腦 LED 顯示 /

質料: 防指紋不銹鋼
機身尺寸: 900 闊 x 308 - 485 深 x 500-980 高 (毫米)
附加: 可配置活性炭過濾器

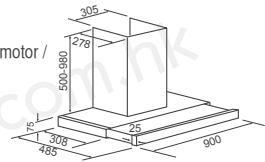

CI928ES  Made in Italy

\$6,700



Specifications: 4 Speeds level / Air flow: 1000m³/hr /
High speed turbo motor / 150mm diameter outlet /
Booster/ Timer/ Touch control

Material: Stainless steel
Filter: Washable metal filter /
Power: AC 230V/ 50Hz
Dimension : 900W x 480D x 690-1155H (mm)

***Options :** Activated Charcoal carbon filter
規格: 四段風速選擇 /
抽風量 - 每小時 1000 立方米 /
高速渦輪式摩打 / 150 毫米直徑出風位 /
增壓器 / 定時器 / 觸控式控制

質料: 不銹鋼
過濾器: 可洗式金屬過濾器 /
機身尺寸: 900 闊 x 480 深 x 690-1155 高 (毫米)
*** 附加:** 可配置活性炭過濾器

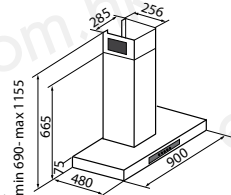

CI918ES  Made in Italy

\$6,900



Specifications: 4 Speeds level / Air flow: 1000m³/hr
High speed turbo motor / 150mm diameter outlet

Material: Stainless steel
Filter: Washable metal filter / Booster/ Timer/ Touch control
Dimension : 900W x 500D x 645-1110H (mm)

*** Options :** Activated Charcoal carbon filter
規格: 四段風速選擇 /
抽風量 - 每小時 1000 立方米 / 增壓器 /
150 毫米直徑出風位

質料: 不銹鋼
過濾器: 可洗式金屬過濾器
高速渦輪式摩打 / 定時器 / 觸控式控制
電源要求: AC 230V/ 50Hz
機身尺寸: 900 闊 x 500 深 x 645-1110 高 (毫米)
*** 附加:** 可配置活性炭過濾器

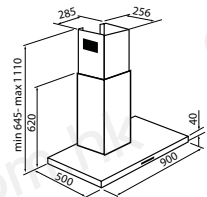

Chimney Type Hood 煙導式抽油煙機

C9009ES

\$5,380



Specifications: 3 Speed levels / Push button control / 150mm diameter outlet / Airflow - 1000m³hr / High speed turbo motor / Micro computer LED display

Material: Anti-fingerprint stainless steel

Dimension: 900W x 405D x 550-920H (mm)

Options: Activated Charcoal carbon filter

規格: 三段風速選擇 / 按掣式控制 / 150 毫米直徑出風位 / 抽風量 - 每小時 1000 立方米 / 高速渦輪式摩打 / 微電腦 LED 顯示

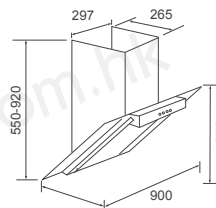

質料: 防指紋不銹鋼

機身尺寸: 900 闊 x 405 深 x 550-920 高 (毫米)

***附加:** 可配置活性炭過濾網

C9015A

\$6,380



Specifications: 3 Speed levels + turbo mode / Touch control / 150mm diameter outlet Airflow - 1000m³ hr / High speed turbo motor/ Micro computer LED display

Material: Tempered Glass

Dimension: 900W x 430D x 530-1480H (mm)

Options: Activated Charcoal carbon filter

規格: 三段風速選擇 + 高速模式 / 輕觸式控制 / 150 毫米直徑出風位 / 抽風量 - 每小時 1000 立方米 / 高速渦輪式摩打 / 微電腦 LED 顯示

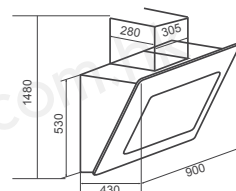

質料: 強化玻璃

機身尺寸: 900 闊 x 430 深 x 530-1480 高 (毫米)

***附加:** 可配置活性炭過濾網

C9019ES

\$5,880



With remote control
備有遙控

Specifications: 3 Speed levels / Push button control / Super silence / 150mm diameter outlet / Airflow - 800m³ hr / High speed turbo motor / Oil cup

Material: Anti-fingerprint stainless steel

Dimension: 900W x 460D x 860-1230H (mm)

Options: Carbon filter

Remarks: External exhaust pipe can be avoided when using carbon filter with remote control

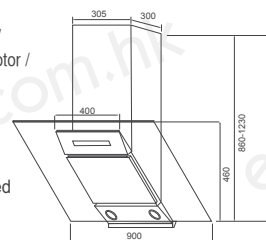

規格: 三段風速選擇 / 按掣式控制 / 超寧靜系統 / 150 毫米直徑出風位 / 抽風量 - 每小時800 立方米 / 高速渦輪式摩打 / 備有油罩

質料: 防指紋不銹鋼

機身尺寸: 900 闊 x 460 深 x 860-1230 高 (毫米)

***附加:** 可配置活性炭過濾網

注意: 使用活性炭過濾網, 可免裝排氣管

Standard Type Hood 櫃底式抽油煙機

F7028MG (Standard type) 櫃底式抽油煙機

\$2,080



Color
■ Grey 灰色

Specifications: 2 Speed levels / Push button control /
150mm diameter outlet /
Airflow - 1005m³/hr / High speed turbo motor /
Slim design / Easy clean metal finishing /
Super silence system
150° slightly tilted base / Carbon filter /
Easy dismantle and clean design

Dimension: 710W x 517D x 100H(mm)
規格: 二段風速選擇 / 按掣式控制 /
150 毫米直徑出風位 /
抽風量 - 每小時 1005 立方米 /
高速渦輪式摩打 / 超薄機身設計
超硬易潔金屬塗層 / 靜音系統 /
150° 傾斜聚油回集設計 /
已配置活性炭過濾器 / 易拆易潔設計
機身尺寸: 710 闊 x 517 深 x 100 高 (毫米)

Telescopic Type Hood 抽拉式抽油煙機

T600GT / T900GT

Italy Made In *Italy*

\$3,380 / \$3,680



Specifications: 3 Speed levels / Push button control /
150mm diameter outlet / Airflow - 1000m³/hr /
Super speed turbo motor / Super silence system
Material: Anti-fingerprint stainless steel
Dimension: **T600GT:** 598W x 280D x 300H(mm)
T900GT: 898W x 280D x 300H(mm)
Options: Activated Charcoal carbon filter
120mm diameter outlet

規格: 三段風速選擇 / 按掣式控制
150 毫米直徑出風位
抽風量 - 每小時 1000 立方米 /
高速渦輪式摩打 / 靜音操作
質料: 防指紋不銹鋼

機身尺寸: **T600GT:** 598W x 280D x 300H(mm)
T900GT: 898W x 280D x 300H(mm)
附加: 可配置活性炭過濾器
可配置 120 毫米直徑轉換器

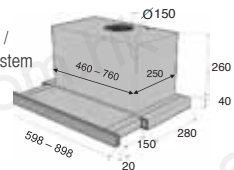

Telescopic Type Hood 抽拉式抽油煙機

T60ES / T90ES

Italy Made In

\$1,980 / \$2,580



Specifications: 3 Speed levels (with lighting) /
120mm diameter outlet /
Airflow - 700m³ hr /
Push button control /
Super speed turbo motor

Dimension: T60ES: 598W x 280-450D x 180H (mm)
T90ES: 898W x 280-450D x 180H (mm)

Options: Activated Charcoal carbon filter

規格： 三段風速選擇 / 120 毫米直徑出風位 /
抽風量 - 每小時 700 立方米 /
按掣式控制 / 高速渦輪式摩打

機身尺寸： T60ES: 598 闊 x 280-450 深 x 180 高 (毫米)

T90ES: 898 闊 x 280-450 深 x 180 高 (毫米)

附加： 可配置活性炭過濾器

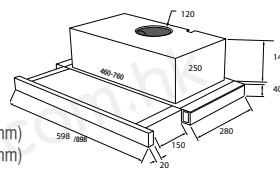

WINE CELLAR 酒櫃

Precise electronic temperature and humidity zoning control for wine storage



Wine Cooler 酒櫃

CW-168DES

\$11,800

Double temperature zone 雙溫區



Capacity:

154 bottles (Volume 750ml)

Temperature:

Upper compartment 5-12 °C

(Suitable for storing both white wine and sparkling wine)

Lower compartment 12-18 °C

(Suitable for storing red wine)

Shelves:

13 full + 1 semi-storage wooden shelves

Door:

Tinted glass with stainless steel door frame

Door lock

Function:

Cool air circulation system

No frost design

No water dropping

Anti-vibration system

Accurate computerized thermostatic

temperature control

Dimension:

595W x 685D x 1800H (mm)

容量

154 瓶 (每瓶 750 毫升)

溫度

上溫區 5-12 °C

(適合存放白酒及氣酒)

下溫區 12-18 °C

(適合存放紅酒)

層架

13 個木製全架 + 1 個木製半架

櫃門:

不銹鋼門框及防紫外光玻璃

門鎖

功能:

冷風循環

無霜設計

無水滴設計

寧靜防震系統

自動電子溫度恆溫控制

尺寸:

595 闊 x 685 深 x 1800 高 (毫米)

CW-168SES

\$10,800

Single temperature zone 單溫區



Capacity:

166 bottles (Volume 750ml)

Temperature:

5-18 °C

Shelves:

14 full + 1 semi-storage wooden shelves

Door:

Tinted glass with stainless steel door frame

Door lock

Function:

Cool air circulation system

No frost design

No water dropping

Anti-vibration system

Accurate computerized thermostatic

temperature control

Dimension: 595W x 685D x 1800H (mm)

容量:

166 瓶 (每瓶 750 毫升)

溫度:

5-18 °C

層架:

14 個木製全架 + 1 個木製半架

櫃門:

不銹鋼門框及防紫外光玻璃

門鎖

功能:

冷風循環

無霜設計

無水滴設計

寧靜防震系統

自動電子溫度恆溫控制

尺寸: 595 闊 x 685 深 x 1800 高 (毫米)

Wine Cooler 酒櫃

CW-100SES

\$9,280

Single temperature zone 單溫區



Capacity:

121 bottles (Volume 750ml)

Temperature:

5-18 °C

Shelves:

10 full + 1 semi-storage wooden shelves

Door:

Tinted glass with stainless steel door frame

Door lock

Function:

Cool air circulation system

No frost design

No water dropping

Anti-vibration system

Accurate Computerized thermostatic

temperature control

Dimension: 595W x 685D x 1430H (mm)

容量:

121 瓶 (每瓶 750 毫升)

溫度:

5-18°C

層架:

10 個木製全架 + 1 個木製半架

櫃門:

不銹鋼門框及防紫外光玻璃

門鎖

功能:

冷風循環

無霜設計

無水滴設計

寧靜防震系統

自動電子溫度恆溫控制

尺寸: 595 闊 x 685 深 x 1430 高 (毫米)

Please refer to fig.1 before installation of wine cooler 請參閱指示，然後安裝酒櫃

CW-45DES

\$6,980

Double temperature zone 雙溫區



Capacity:

45 bottles (Volume 750ml)

Temperature:

• Upper compartment 5-10 °C

(Suitable for storing both white wine and sparkling wine)

• Lower compartment 10-18 °C

(Suitable for storing red wine)

Shelves:

4 full + 1 semi-storage wooden shelves

Door:

Tinted glass with stainless steel door frame

Door lock (right hinge)

Function:

Special design for under counter installation

Cool air circulation system

No frost design

No water dropping

Anti-vibration system

Computerized thermostatic

temperature control

Dimension: 598W x 575D x 820H (mm)

容量:

45 瓶 (每瓶 750 毫升)

溫度:

• 上溫區 5-10 °C

(適合存放白酒及氣酒)

• 下溫區 10-18 °C

(適合存放紅酒)

層架:

4 個木製全架 + 1 個木製半架

櫃門:

不銹鋼門框及防紫外光玻璃

門鎖 (右鉸)

功能:

特別設計適合櫃下安裝

冷風循環

無霜設計

無水滴設計

寧靜防震系統

自動電子溫度恆溫控制

尺寸: 598 闊 x 575 深 x 820 高 (毫米)

Wine Cooler 酒櫃

Please refer to fig.1 before installation of wine cooler 請參閱指示，然後安裝酒櫃

CW-18B

\$4,280

Single temperature zone 單溫區



Capacity:

18 bottles (Volume 750ml)

Temperature:

5-18 °C

Shelves:

5 full + 1 semi-storage wooden shelves

Door:

Tinted glass with stainless steel door frame

Function:

Special design for under counter installation

Cool air circulation system

No frost design

No water dropping

Anti-vibration system

Computerized thermostatic temperature control

容量:

18 瓶 (每瓶 750 毫升)

溫度:

溫度: 5-18 °C

層架:

5 個木製全架 + 1 個木製半架

櫃門:

不銹鋼門框及防紫外光玻璃

功能:

特別設計適合櫃下安裝

冷風循環

無霜設計

無水滴設計

寧靜防震系統

自動電子溫度恆溫控制

Dimension: 300W x 595D x 820H (mm)

尺寸: 300 闊 x 595 深 x 820 高 (毫米)

CW22SBS

\$3,280

Single temperature zone 單溫區



Capacity:

7 bottles (Volume 750ml)

Temperature:

Temperature: 11-18 °C

Shelves:

6 wine shelves

Door:

Tinted glass with stainless steel door frame

Function:

Stainless steel door and handle

Thermoelectric cooling

Adjustable thermostat for ideal temperature control

Soft interior lighting with ON/OFF switch

Dimension: 165W x 525D x 823H (mm)

容量:

7 瓶 (每瓶 750 毫升)

溫度:

溫度: 11-18 °C

層架:

6 個金屬鋼架

櫃門:

不銹鋼門框及防紫外光玻璃

功能:

不銹鋼門和把手

電子制冷

電子溫度恆溫控制

內置柔和照明燈開關

不銹鋼門框及防紫外光玻璃

尺寸: 165 闊 x 525 深 x 823 高 (毫米)

Procedures and Installation Details

安裝程序和細節

- Please reserve minimum 50mm spacing from the back wall.
- Minimum 10mm spacing must be ensured from all side walls.
- 請嚴格按照程序:
- 所有側牆必須得到最小距離為 50mm 的保證。
- 酒櫃上方及左右側牆必須有最小 10 mm 空間距離

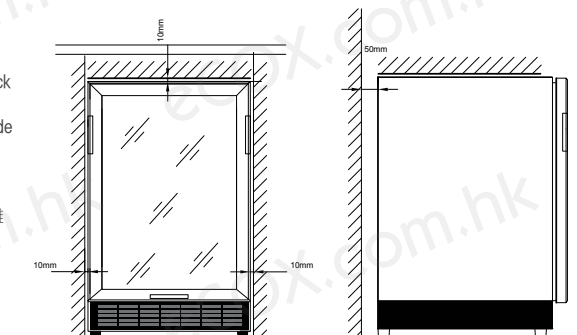



REFRIGERATOR 雪櫃

Perfect food storage system

Refrigerator 雪櫃



V255MW (Free standing model) 獨立式雪櫃

(white) 白 \$3,380 (silver) 銀 \$3,480



ENERGY LABEL

Grade **1** 級

HK Energy label : Grade 1

Total gross capacity : 245 liters

Net capacity fridge compartment : 173 liters

Net capacity freezer compartments : 72 liter

Freezer compartment star rating : **★★★★**

Specifications:

- Reversible doors / Adjustable shelves / Twist ice tray / Vegetable drawer
- Frost free / Flat back and adjustable feet / Recessed handle

Dimension : 548W x 619D x 1633H (mm)

香港能源標籤 : 1 級

總容量 : 245 公升

保鮮格淨容量 : 173 公升

冰格淨容量 : 72 公升

冷凍級數 : **★★★★**

規格 :

- 可選擇櫃門左右開關 / 可調校盛物架 / 制冰格 / 蔬果保鮮室
- 無霜系統 / 平滑機背及可調校櫃腳高度 / 隱藏式手把

尺寸 : 548 闊 x 619 深 x 1633 高 (毫米)

Refrigerator 雪櫃

V910ES (Free standing model) 獨立式雪櫃 *Made in Europe*  \$22,800



Total gross / net capacity: 620 liters / 526 liters

Net capacity fridge compartment: 362 liters

Net capacity freezer compartment: 164 liters

Specifications

- Convertible freezer sections
- Double compressor
- Touch screen electronic display on door
- Flat doors with recessed handles
- Hidden led lighting from fridge cabinet and door interior LED light
- Illuminated Handles (optional)
- Self-Close Fresh Zone

VitaStor

- Storage conditions (2°C)
- Humidity level (90% RH)
- Temperature-sensitive fan
- Cooling air

Dimension: 910W x 750D x 1850H (mm)

Side Cabinet: 660D(mm)

總容量 合重/淨重: 620 / 526公升

保鮮格淨容量: 362 公升

冰格淨容量: 164 公升

規格:

- 可轉換冰櫃部分
- 雙壓縮器
- 輕觸電子顯示屏幕
- 平板門具有凹入把手
- 冰箱和門室內具有隱藏式LED照明
- 照明手柄 (可選)
- 自動關閉保鮮區

VitaStor

- 理想的儲存狀態 (2°C)
- 濕度 (90% RH)
- 溫度感應風扇技術
- 冷卻空氣

尺寸: 910闊 x 750深 x 1850高 (毫米)

邊櫃: 660深(厘米)

ENERGY



V911ES (Free standing model) 獨立式雪櫃 *Made in Europe*  \$22,500



Total gross / net capacity: 645 liters / 529 liters

Net capacity fridge compartment: 362 liters

Net capacity freezer compartment: 167 liters

Specifications

- Touch screen electronic display on door
- Cold Wrap Cooling
- Superior Internal Illumination
- Fresh Zone with Self-Close
- Super Quick Freeze & Cool
- Economy Mode for Energy Saving
- Leaveling Feet

Dimension: 910W x 760D x 1850H (mm)

總容量 合重/淨重: 645 / 529公升

保鮮格淨容量: 362 公升

冰格淨容量: 167 公升

規格:

- 輕觸電子顯示屏幕
- 冷凍包裹冷卻
- 超級內部照明
- 自動關閉保鮮區
- 超快速凍結及散熱
- 經濟模式有助節省電能
- 調平腳

尺寸: 910闊 x 760深 x 1850高 (毫米)

ENERGY



Built-in Refrigerator 內置式雪櫃

BS285EW-1 (Built-in refrigerator) 內置式雪櫃

\$9,380



Total gross capacity: 237 liters
Net capacity fridge compartment: 176 liters
Net capacity freezer compartment: 61 liters

Specifications

- 3 adjustable safety glass shelves
 - Fridge: automatic defrost
 - Freezer: No Frost
- Dimension:** 555W x 540D x 1770H (mm)

總容量 : 237公升
保鮮格淨容量 : 176 公升
冰格淨容量 : 61 公升

規格 :

- 3 個可調校安全盛物架
 - 保鮮格 : 自動溶雪
 - 冰格 : 無霜系統
- 尺寸 : 555 闊 x 540 深 x 1770 高 (毫米)

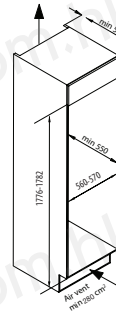

ENERGY LABEL

grade **1** 級

BV160EW (Built-in under counter refrigerator) 枱下型內置式雪櫃

\$4,980



ENERGY LABEL

grade **1** 級

HK Energy label : Grade 1

Total gross capacity: 108 Liters
Net capacity fridge compartment: 88 Liters
Net capacity freezer compartment: 20 Liters

Specifications

- Adjustable temperature control
 - 2 adjustable safety glass shelves
 - Fridge automatic defrost
 - Freezer manual defrost
- Dimension:** 598W x 545D x 820H mm

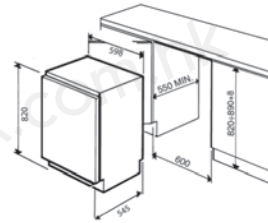

香港能源標籤 : 1 級

總容量 : 108 公升
保鮮格淨容量 : 88 公升
冰格淨容量 : 20 公升

規格 :

- 可調校冷凍溫度系統
 - 2 個可調校安全盛物架
 - 保鮮格 : 自動溶雪
 - 冰格 : 手動除霜
- 尺寸 : 598 闊 x 545 深 x 820 高 (毫米)

CRISTAL
Italy

WDC1260FMW

NEW GENERATION INVERTER WASHING/DRYER

新一代變頻洗衣乾衣機



Digital Inverter Motor:

Quiet, reliable and energy efficient
自動變頻模式: 寧靜, 節能



Digital Lock Function

Enable to increase the quantity of clothes during washing
安全電磁門鎖, 可於洗衣途中添加衣物



Sensor Dry Programmes

智能乾衣系統: 乾衣完成後自動停止運作



Imbalance Control System

HPM 平衡系統, 當轉動時防止機身震動



Wave Drum Design:

Washing with Gentle, fabrics don't catch in the cubic drum and subsequently not damaged.
波浪式滾筒設計, 不損衣物



Quantity Control Mode

洗衣量自選模式

Washer & Dryer 洗衣乾衣機

WDC1260FMW (Free standing model) 座地式

\$5,980



Quick wash program
智快洗衣程序

12分鐘
12min



ENERGY LABEL

Grade 1 級

HK Energy label : Grade 1

Washing capacity: 6 kg

Drying capacity: 3 kg

Washing temperature: cold to 90°C

Spin speed: 400-1200rpm

- 9 washing programmes
- 1 drying programme
- Electronic control operation
- Automatic consumption reduction
- LED display
- Delay start timer with countdown indicator
- Spin and temperature selection buttons
- Child lock safety function
- Stainless steel drum
- Adjustable feet
- Error code failure system
- Overflow protection
- Foam protection
- Self-adjusting water level
- Self-clean function (drum cleaning)

Dimension :

• 595W x 540D x 850H (mm)

Height: (without cover): 825 mm

1 級能源標籤

洗衣量：6kg

乾衣量：3kg

洗衣溫度：冷水至 90 度

脫水轉速：400-1200 轉 / 分鐘

- 9 種洗衣程序
- 1 種乾衣程序
- 電子控制
- 環保節約功能，省水，省電
- LED 特大顯示屏
- 延遲啟動定時器，剩餘時間指示器
- 可擇水溫 / 脫水轉速調節
- 兒童安全鎖功能
- 不銹鋼內桶
- 可調節底腳
- 錯誤代碼故障系統
- 防漏保護
- 防泡沫保護
- 自動調節水量
- 自動清潔臉內桶功能

尺寸：

• 595 闊 x 540 深 x 850 高 (毫米)

高度：825 毫米 (不包括頂蓋)

WD1200FMW (Built-in model) 嵌入式

\$7,980



ENERGY LABEL

Grade 1 級

HK Energy label : Grade 1

Washing Capacity: 6 kg

Drying Capacity: 3 kg

Spin Speed: 400-600-1000-1200 rpm

- Electronic control
- Eco programme
- 12 washing programs
- 3 drying programs
- LED display
- Delay start timer with remain time indicator
- Extra rinse option function
- Spin and temperature selection buttons
- Door safety lock
- Child lock safety function
- Stainless steel drum and tank
- Adjustable feet
- Error code failure system
- Audible signal at end of wash cycle

Dimension:

595 (W) x 560 (D) x 825 (H) mm

1 級能源標籤

洗衣量：6kg

乾衣量：3kg

脫水轉速轉速：400-600-1000-1200 轉 / 分鐘

- 電子控制
- 節能洗衣模式
- 12 種洗衣程序
- 3 種乾衣程序
- 液晶顯示器
- 延遲啟動定時器，剩餘時間指示器
- 額外清洗功能
- 可擇水溫 / 脫水轉速調節
- 門安全鎖
- 兒童安全鎖功能
- 不銹鋼內桶
- 可調節底腳
- 錯誤代碼故障系統
- 洗滌週期結束時；聲音信號提醒

尺寸：

• 595 闊 x 560 深 x 825 高 (毫米)

KITCHEN TV 廚房電視

Makes cooking easy under chef's instruction



C-KTV102

\$5,980

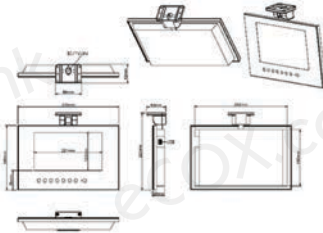

Visible diagonal: 10"

Dynamic contrast ratio: 450:1

Brightness: 300cd/m²

Aspect ratio: 16 : 9

Contrast ratio: 600:1

Viewing angle (H/V): H:±120° V:±120°

Resolution: 1280(H)* 800(V)

Broadcasting system: PAL, NTSC, SECAM

In & Out jacks: RF Input

Response time: 16ms

Features

Built in HDTV tuner/ Built-in speaker/Auto channel search/ Wireless Infrared Remote control (dry battery included)

Dimension :
270W x 180H x 39D mm

畫面尺寸 :10"

動態對比度 : 450:1

光亮度 : 300cd/m²

畫面比例 : 16:9

可視角度 (水平 / 垂直) : ±120° / ±120°

解像度 : 1280 x 800

廣播制式 : PAL, NTSC, SECAM

輸入及輸出 : RF Input

反應時間 : 16ms

配備 :

內置高清電視頻道調節器
內置喇叭 · 自動頻道搜尋器 · 遙控器

尺寸 :
270 闊 x 180 高 x 39 深 (毫米)

C-KTV10

\$3,380

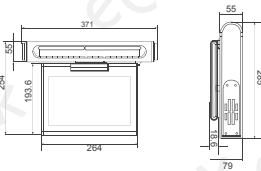

Signal: Analogue

Visible diagonal: 10.2"

Dynamic contrast ratio: 450:1

Brightness: 300cd / m²

Aspect ratio: 16 : 9

Resolution: 800 x 600

Broadcasting system: PAL, NTSC, SECAM

In & Out jacks: RF Input

Features

FM Radio / Built-in Speaker /
Built-in DVD player / Auto Channel Search
Wireless Infrared Remote Control

Dimension :
371W x 79H x 285D (mm)

信號 : 標清

畫面尺寸 :10.2"

動態對比度 : 450:1

光亮度 : 300cd/m²

畫面比例 : 16:9

解像度 : 800x600

廣播制式 : PAL, NTSC, SECAM

輸入及輸出 : RF Input

配備 :

FM 無線收音機功能 / 內置揚聲器 /
內置 DVD 播放器 / 自動頻道搜尋器 /
遙控器

尺寸 :
371 闊 x 79 高 x 285 深 (毫米)

Bathroom waterproof TV 浴室防水電視

BATHROOM WATERPROOF TV

Maximize your entertainment and enjoyment at a touch



BKW191 浴室防水電視

\$9,900



Diagramme for Model: BKW191 (Mirror)

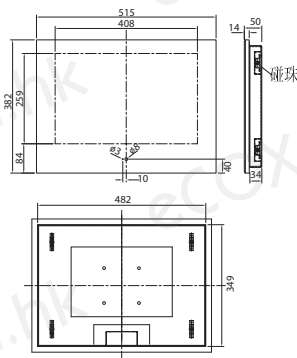

Visible diagonal: 19.1"
Contrast ratio: 700:1
Brightness: 600cd / m²
Aspect ratio: 16 : 9
Viewing angle (H/V): ±160 / ±160
Resolution: 1366 x 768
Broadcasting system: PAL , NTSC
In & out jacks: RF Input

- Built-in analog and digital tuner
- Built-in waterproof speaker
- Light sensation touch control
- Auto channel search
- Waterproof Standard IP65
- Wireless infrared remote control
- Silver/Mirror frame available

Custom-made sizes available (Visible Diagonal)

- 10.2", 15.4", 17.1", 22", 26", 32", 37" & 42"

There are other styles available to order

Dimension:

- 382W x 515H x 55D (mm)

畫面尺寸: 19.1"
動態對比度: 700:1
光亮度: 600cd/m²
畫面比例: 16:9
可視角度 (水平 / 垂直): ±160/±160
解像度: 1366 x 768
廣播制式: PAL, NTSC
輸入及輸出: RF Input

- 內置類比及數碼頻道調節器
- 內置防水揚聲器
- 感光輕觸控制
- 自動頻道搜尋器
- 防水級別 IP65
- 遙控器
- 另有銀色 / 鏡面外框可供選擇

另有訂造尺寸: 可供選擇 (畫面尺寸:)

- 10.2", 15.4", 17.1", 22", 26", 32", 37" & 42"

另有其他款式可供訂購

尺寸:

- 382 闊 x 515 高 x 55 深 (毫米)

Optional Models:



Model: BKW191 (slim type)
Diagramme size to be advised



Model: BKW191 (Standard type)
Diagramme size to be advised



Model: BKW191 (Mirror)
Diagramme size to be advised

BUILT-IN STERILIZER 嵌入式消毒碗櫃

Eco-friendly way to store and sterilize cooking utensil and tablewares

D32DSS

\$2,780



Function:
Built-in double deck design
Reinforced disinfection protection
PTC hot air circulation ($\leq 70^{\circ}\text{C}$)
Timer

Dimension:
595W x 415D x 600H (mm)

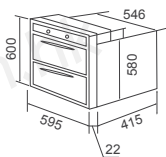

功能:
嵌入式雙層設計
臭氧及紫外光消毒功能
熱風循環烘乾功能： $(\leq 70^{\circ}\text{C})$
時間設定功能

尺寸:
595 闊 x 415 深 x 600 高 (毫米)

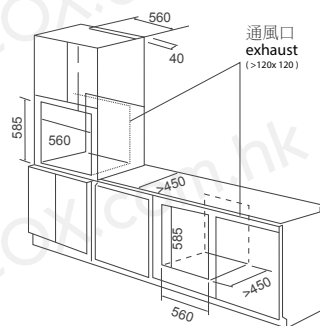

D36DSS

\$3,180



Function:
Built-in double deck design
Reinforced disinfection protection
PTC hot air circulation ($\leq 70^{\circ}\text{C}$)
Timer

Dimension:
595W x 415D x 600H (mm)

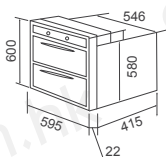

功能:
嵌入式雙層設計
臭氧及紫外光消毒功能
熱風循環烘乾功能： $(\leq 70^{\circ}\text{C})$
時間設定功能

尺寸:
595 闊 x 415 深 x 600 高 (毫米)

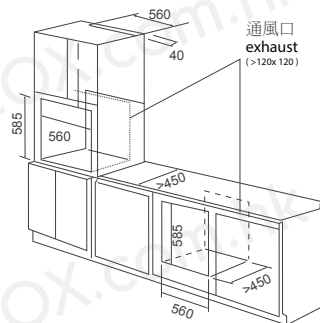

HONG KONG AND MACAU JOB REFERENCES

Choice of Renowned Property Developers, Hotels and Listed Companies in Hong Kong;
Quality Assurance and Excellent Reputation

香港著名地產 / 酒店及權威上市公司選用，信心保證，信譽超卓



Island Crest
堅尼地城繡城峰



Metro Town
調景嶺都會駅



Oceanaire
馬鞍山天宇海



The Balmoral
大埔承峰



Oceanfront Phase 6
馬灣珀麗灣 6 期



Stanley Regalia Bay
赤柱富豪海灣

Throughout the years, Cristal has been providing high-quality home appliances to numerous leading prestige residential projects:

一直以來，Cristal 致力提供高質素家電產品給予多個香港大型私人屋苑：

118 Tung Lo Wan Road	銅鑼灣道 118 號
Avignon	屯門星堤
Baker Court, Hung Hom	必嘉圍
Belgravia	南灣 Belgravia
Casa 880	北角英皇道 880 號
Central Park Towers	天水圍柏慧豪庭 II
Coastal Skyline Phase 4	東涌藍天海岸 4 期
Century Gateway	瓏門 2 期
Hong Kong Garden	荃灣景花園
Island Crest	堅尼地城繡城峰
La Splendeur	領凱
Le Billionaire Phase 1 & 2	九龍城豪門一及二期
Lohas Park Phase 1- The Capital	將軍澳日出康城 - 首都
Lohas Park Phase 2A- Le Prestige	將軍澳日出康城 - 領都
Lohas Park Phase 2B- Le Prime	將軍澳日出康城 - 領峯
Villa de Mer	澳門海天居
Marinella	深灣 9 號
Metro Town	調景嶺都會駅
One West Kowloon	一號西九
One Mayfair	逸瓏
Oceanaire	馬鞍山天宇海
Oceanfront Phase 6	馬灣珀麗灣 6 期
Park Island Phase 5	馬灣珀麗灣 5 期
Providence Bay	天賦海灣
Residence Bel-Air Phase 6	南區貝沙灣 6 期
Seasons Monarch	元朗四季名園
Stanley Regalia Bay	赤柱富豪海灣
The Rise	昇柏山
The Apex	雍雅軒
The Altitude	紀雲峰
The Beaumont	峻瀝
The Balmoral	大埔承峰
The Forest Hill	鑽石山匯豪山
The Hermitage	奧運站帝峰·皇殿
The Spectacle	油塘嘉賢居
The Wings 2	天晉 2 期

Project Reference 曾參與項目

Hotel and service apartments:

酒店及商務酒店：

Banyan Tree Hotels & Resorts w	澳門悅榕莊酒店
Galaxy Macau	澳門銀河酒店
Okura Hotels & Resorts	澳門大倉酒店
One Silver Sea Hotel	一號銀海
Garden East	皇后大道東 214-224 號
Harbour Plaza 8 Degree	8 度海逸酒店
Harbour Grand	海逸君綽酒店
Harbourfront Horizon	紅磡海灣軒 - 海景酒店
Harbourview Horizon	紅磡海韻軒 - 海景酒店
L'hotel Nina et Convention Centre	荃灣如心海景酒店
Queen's Cube	皇后大道東 235 至 245 號
Royal View Hotel	汀九帝景酒店
The Lily	The Lily 淺水灣
V Service Apartment	V Service Apartment
Yi Serviced Apartment	Yi Serviced Apartment
Yin Serviced Apartment	Yin Serviced Apartment



Galaxy Macau
澳門銀河酒店



V Service Apartment



Royal View Hotel
汀九帝景酒店



Yin Serviced Apartment



L'hotel Nina et Convention Centre
荃灣如心海景酒店



Harbour Plaza 8 Degrees
8 度海逸酒店



Harbourview Horizon
紅磡海韻軒 - 海景酒店



Queen's Cube
皇后大道東 235 至 245 號

HONG KONG AND MACAU JOB REFERENCES

Choice of Renowned Property Developers, Hotels and Listed Companies in Hong Kong;
Quality Assurance and Excellent Reputation

香港著名地產/ 酒店及權威上市公司選用, 信心保證, 信譽超卓



Avignon
星堤



Park Metropolitan
觀月·樺峯

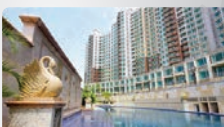

Up Town
尚城



Lion Rise
現崇山



Island Crest
繡城峰

Throughout the years, Cristal has been providing high-quality home appliances to numerous leading prestige residential projects:

一直以來, Cristal 致力提供高質素家電產品給予多個香港大型私人屋苑及服務式住宅:

Altro	懿山
Avignon	星堤
Beneville	聚康山莊
Cadogan	加多近山
Chelsea Court	爵悅庭
Discovery Bay Phase 14 & 15	愉景灣 14及15期
Gateway Apartments	港威豪庭
Grand Court	加林閣
Harmony Place	樂融軒
High Place	曉蒼
High West	曉譽
Island Crest	繡城峰
La Mer - Caribbean Coast Phase 7	東涌映灣園 第7期
Le Billionnaire Phase 1 & 2	御·豪門 1及2期
Lion Rise	現崇山
Metor Town	都會駅
Mount Davis	怡峰
Mount East	曉峰
Mont Vert	鳳園嵐山
Ocean One	Ocean One
One Pacific Heights	盈峰一號
One SilverSea	一號銀海
One South Lane	南里壹號
Park Metropolitan	觀月·樺峯
Sham Wan Towers	深灣軒
Taikoo Place Apartment	太古坊柏舍
Tan Kwai Tsuen	丹桂村
The Avenue	蘭匯
The Gloucester	尚匯
The Hemispheres	維峯
The Morrison	駿逸峰
Trinity Towers	豐匯
Up Town	尚城
Urbana Lofts	御尚軒
Vision City	萬景峰
Winfield Building	雲暉大廈

Hotel and service apartments:

酒店及商務酒店：

Butterfly on Prat Boutique Hotel	晉逸精品酒店
Courtyard by Marriott Hong Kong Shatin	香港沙田萬怡酒店
Galaxy Hotel Phase 2	澳門銀河酒店2期
Harbourfront Horizon	海灣軒
Harbour Grand Hong Kong	港島海逸君綽酒店
Holiday Inn Express	智選假日酒店
Renaissance Hong Kong Harbour View Hotel	香港萬麗海景酒店
Repulse Bay Hotel	香港淺水灣的酒店
Royal Park Hotel	帝都酒店
The Mira Moon Hotel	美麗華精品酒店
The Ritz Calton - Kowloon Station	麗嘉酒店 - 環球貿易廣場第三期



Repulse Bay Hotel
香港淺水灣的酒店



Galaxy Hotel Phase 2
澳門銀河酒店2期



Harbourfront Horizon
海灣軒



Renaissance Hong Kong Harbour View
香港萬麗海景酒店



Royal Park Hotel
帝都酒店



The Mira Moon Hotel
美麗華精品酒店



Courtyard by Marriott
Hong Kong Shatin
香港沙田萬怡酒店



Butterfly on Prat Boutique Hotel
晉逸精品酒店



Great Treasure (Building Supplies & Engineering) Limited
長富（建材及工程）有限公司

Hong Kong Showroom:

2/F. Amber Commercial Building ,
70-74 Morrison Hill Road ,
Causeway Bay, Hong Kong

香港陳列室：

銅鑼灣摩利臣山道 70-74 號

凱利商業大廈 2 樓

Tel: (852) 3118 7449

Fax: (852) 3176 7449

Customer Services Centre:

Block E, 10/F., Mai Tak Industrial
Building, 221 Wai Yip Street,
Kwun Tong, Kowloon, Hong Kong

客戶服務中心：

九龍觀塘偉業街 221 號

美德工業大廈 10 樓 E 座

Tel: (852) 3752 6111

Fax: (852) 2722 1856

Macau Showroom:

Rua Londres , No.196R/C AE,
Edf, Golden Dragon Centre,
Dynasty Area, Macau

澳門陳列室：

澳門皇朝區倫敦街 196 號

金龍中心地下 AE 座

Tel: (853) 2872 3661

Fax: (853) 2872 2861

www.cristal.com.hk

All specifications of this catalogue are subject to change without prior notice. Copyright©2011 all rights reserved

產品規格及外觀如有任何改變，恕不另行通知。版權所有，翻印必究。